

FDS 102 mm DEFLECTION ISOLATOR

S-I UNITS (mm AND kg)

TYPE	L	W	T	A	D	H	TT	Z
4-5500B/8900B	470	203	15	19	17	406	25	32
4-9400B/11600B	470	203	15	19	17	406	32	32

STANDARD RATINGS		SPRING COIL					
TYPE	SIZE	COLOR		FREE		RATED	
		OUTER	INNER	HT.	O.D.	LOAD	DEFL.
FDS	4-5500B	GRAY	GRAY	292	203	2495	102
FDS	4-6000B	GRAY	GRAY	292	203	2722	102
FDS	4-6500B	GRAY	GRAY	292	203	2948	102
FDS	4-7000B	GRAY	GRAY	292	203	3175	102
FDS	4-7700B	GRAY	GRAY	292	203	3493	102
FDS	4-8400B	GRAY		292	203	3810	102
FDS	4-8900B	GRAY	GRAY	292	203	4037	102
FDS	4-9400B	GRAY	GRAY	292	203	4264	102
FDS	4-9900B	GRAY	GRAY	292	203	4491	102
FDS	4-10400B	GRAY	GRAY	292	203	4717	102
FDS	4-10900B	GRAY	GRAY	292	203	4944	102
FDS	4-11600B	GRAY	GRAY	292	203	5262	102

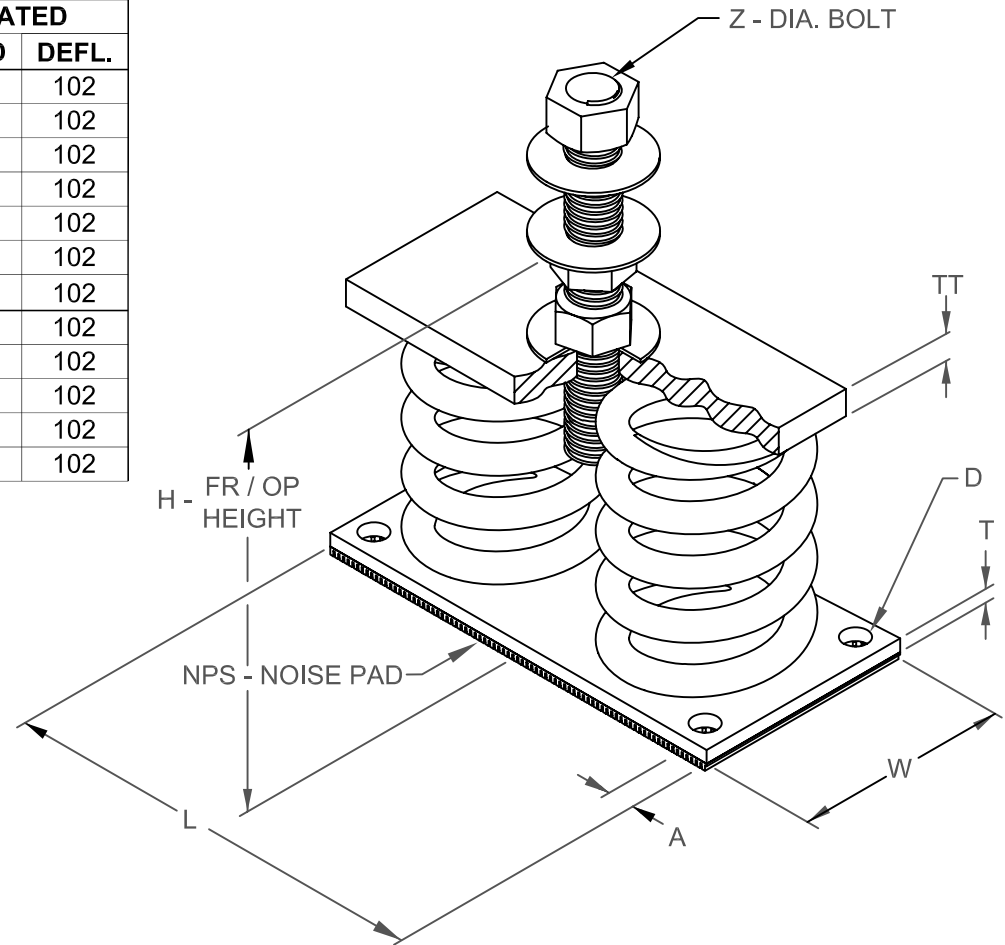

SPECIFICATIONS:

- LOAD PLATES ARE AFFIXED TO COIL SPRING
- FREE STANDING COIL SPRING ISOLATOR
- PAINTED SPRING ELEMENT
- OTHER METALLIC COMPONENTS BRIGHT ZINC PLATED
- MINIMUM OVERLOAD OF 50%
- MINIMUM Kx/Ky RATIO OF 1.0
- ALL ELEMENTS SAFE AT SOLID LOADING
- ALL THREADED MEMBERS ARE AMERICAN STANDARD



KINETICS NOISE CONTROL, INC
 6300 IRELAN PL,
 DUBLIN, OH 43017 USA
 Ph: 614 889-0480, Fax: 614 889-0540
 www.kineticsnoise.com

Model:
FDS-4-5500B/11600B

By: **JMJ**
 Date: **04/19/02**
 Revised: **06/19/03 / JMJ**

Drawing No:
S-01.20-43(M)